



Safety

Your garage door openers have some nice built-in safety features:

- Optical sensors stop garage doors from closing on someone or something
- Safety Reversal System senses resistance against the door and will reverse itself if it encounters elevated resistance in case of entrapment



Important: Do not attempt to adjust tension spring, as this can cause serious injury or death. Consult a professional if adjustments are needed.

General operations:

- Push main button on wall to operate door, and smaller button to operate light
- Pull cord to release from opener to operate manually
- Push button (or largest button if multiple) on remote to operate garage door

Wifi Enabled Garage Door Help:

- [LiftMaster myQ Support](#)
- [Genie Aladdin Connect Support](#)

GENIE CUSTOMER
SUPPORT

LIFTMASTER
SUPPORT

AMARR SERVICE
& SUPPORT

WAYNE DALTON
CUSTOMER SERVICE

CLOPAY SERVICE
& SUPPORT

CUSTOMER CARE
WARRANTY REQUEST



Maintenance and cleaning:

Batteries

- If the remote or keypad no longer operates as expected, change the batteries to see if that solves the problem.

Every Six Months

- Manually operate the door; if it is unbalanced or binding, call a trained door systems technician
- Check to be sure the door opens and closes fully; adjust if necessary
- Test the safety reversal system; adjust if necessary

GENIE CUSTOMER
SUPPORT

LIFTMASTER
SUPPORT

AMARR SERVICE
& SUPPORT

WAYNE DALTON
CUSTOMER SERVICE

CLOPAY SERVICE
& SUPPORT

CUSTOMER CARE
WARRANTY REQUEST

Every Year

- Oil bearings and hinges; the garage door opener does not require additional lubrication; do not grease the door tracks
- Test the battery backup (if applicable) and consider replacing the battery to ensure the garage door opener will operate during a power outage
- Pressure-wash the door

Every Two to Three Years

- Use a rag to wipe away the existing grease from the garage door opener rail
- Reapply a small layer of white lithium grease to the top and underside of the rail surface where the trolley slides

**GENIE CUSTOMER
SUPPORT**

**LIFTMASTER
SUPPORT**

**AMARR SERVICE
& SUPPORT**

**WAYNE DALTON
CUSTOMER SERVICE**

**CLOPAY SERVICE
& SUPPORT**

**CUSTOMER CARE
WARRANTY REQUEST**

Remotely monitor & control garage door, provide virtual keys to people you trust, schedule times for door to automatically close

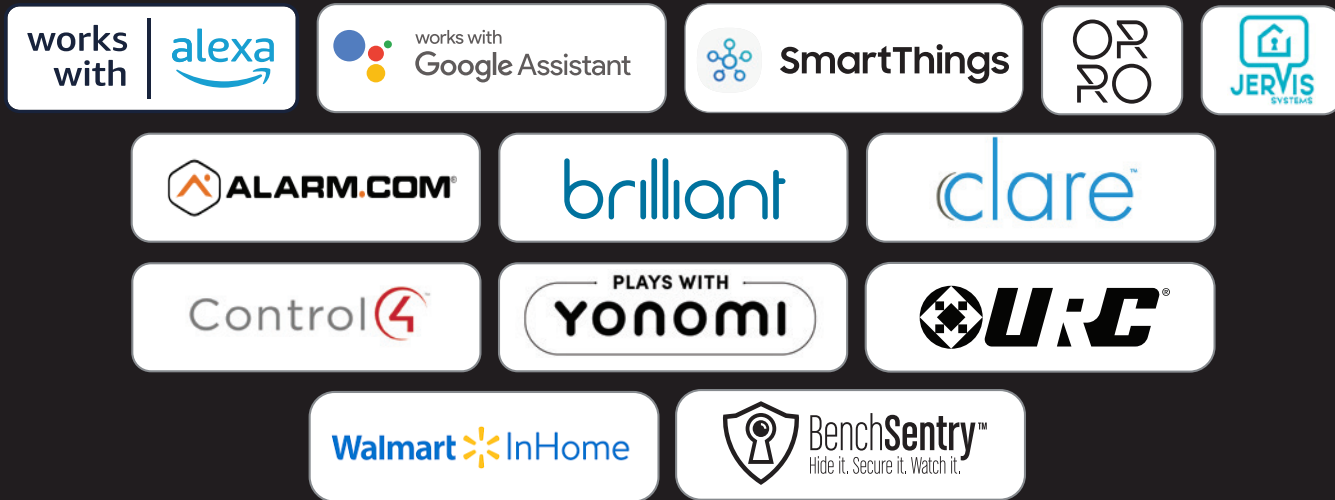

The Genie Company may add more smart platforms and home delivery channels to its Aladdin Connect® compatibility list as it continues to expand. Go to www.geniecompany.com for most current listing if you don't see yours listed here.



Homelink® and Car2U®

Programming a Homelink® System

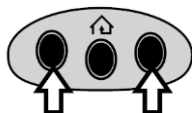

Step 1 Clear Homelink

Clear Homelink by pressing and holding down the first and third buttons until the indicator on the Homelink blinks slow and then fast for 20 seconds; then release both buttons.

NOTE: Clearing the Homelink will remove all previously programmed garage door openers.

Step 2 Train Homelink to the Genie Remote

Choose the button on the Homelink to be used to open the door.

NOTE: Hold the Genie Remote two inches from the Homelink button.

Hold down the Genie remote button. While holding, press and hold the chosen Homelink button. Hold down both buttons until the indicator on the Homelink blinks slow then fast. Once it blinks, release both buttons.

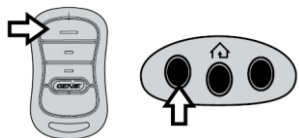

Step 3 Program Homelink to the Genie Opener

A. Press and hold **PRGRM SET** button on the opener until the round blue LED is ON. Release the button. The long LED will flash purple.

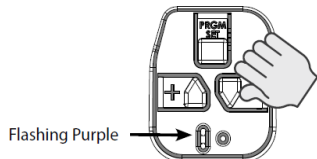

B. Press the chosen Homelink button for two seconds and release. Press that same button again for two seconds and release. The long LED at the powerhead will flash blue and then turn off.

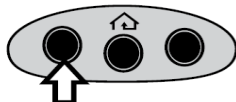

C. Press the Homelink button a few more times until the door moves.

NOTE: For additional instructions, see the motor vehicle manual, www.homelink.com or visit www.GenieCompany.com

Programming a Car2U® System

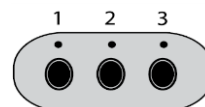

Step 1 Clear Car2U to default settings

The default setting for the Car2U system is:

- Button 1 = Genie® Manufactured Openers
- Button 2 = LiftMaster® Manufactured Openers
- Button 3 = Wayne Dalton® Manufactured Openers

A. Press and hold buttons 1 and 3 for 20 seconds or until all three LEDs begin to flash.

B. Release both buttons. The Car2U system is now set to the Factory Default settings.

NOTE: Clearing the Car2U system will remove all programmed garage door openers.

Step 2 Program Car2U to the Genie Opener

A. Press and hold the **PRGRM SET** button on the opener until the round blue LED is ON—release the button. The long purple LED will begin flashing.

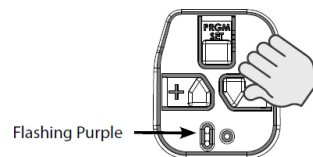

B. Press the designated Genie Car2U button for two seconds and release. Press that same button again for two seconds and release. At the powerhead, the long LED will flash blue and then turn off.

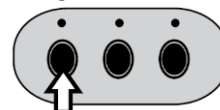

C. Press the Car2U button a few times more until door moves.

Step 3 Changing Factory Default Button for a Genie Opener

A. Press and hold buttons 1 & 3 for **ONE SECOND** and release—all three LEDs will turn on solid red.

B. Press and hold the button (2 or 3) to change it to Genie—the corresponding LED will flash. While continuing to hold that button press and release button 1. Press and release button 1 again.

C. Release the button being held in step B and wait for the LED to stop flashing. This button is now set for Genie. Repeat Step 2 for second Genie Opener.

NOTE: For additional instructions see the motor vehicle manual, learcar2u.com or visit www.GenieCompany.com

Need help or have any questions? Call our technical hotline at (800) 843-4084 option 3.



PROFESSIONAL LINE

Wireless Keypad

Keypad Overview

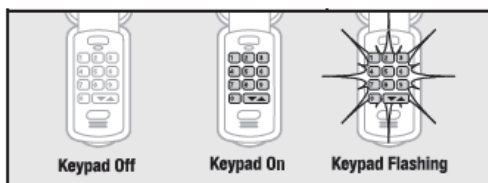
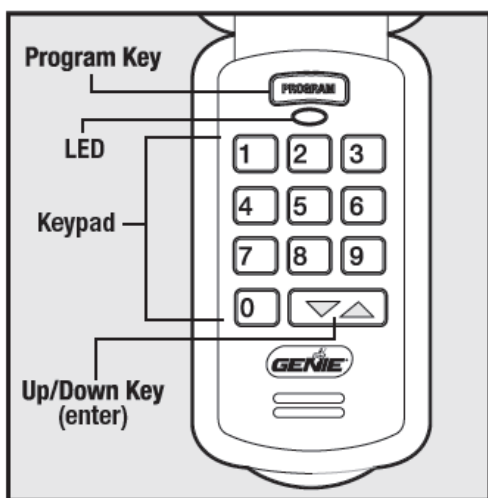
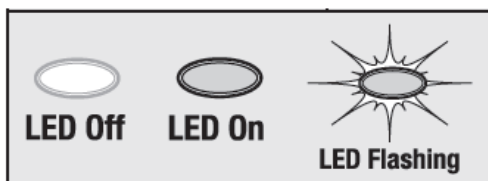

Setting the PIN for the First Time:

1. Press in order the numbers



2. Press the **PROGRAM** key
3. Type a new PIN (3-8 digits)
4. Press the **PROGRAM** key again

The keypad is ready to program to an opener.

For use on a Single Door go to:
Synchronizing Keypad to One Door. For 2-3 Doors, go to **Synchronizing Multiple Doors.**

Powerhead Models Follow the Same Steps

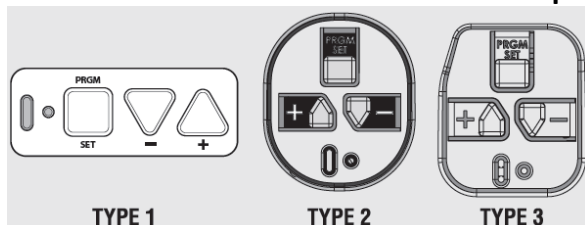

Synchronizing the Keypad to One Door:

1. Press **PROGRAM SET** button for two seconds until the round LED turns blue, release. The long purple LED will blink.
2. Key in the new PIN on the keypad.
3. Press Up/Down key and opener LEDs stay on.
4. Press Up/Down key again and opener LEDs go off.
5. Press Up/Down key a third time and opener runs.

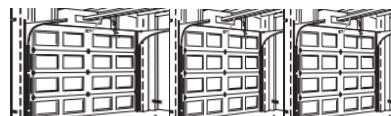

Synchronizing Multiple Doors up to three:

1. Key in the new PIN on the keypad (3-8 digits).
2. Press the **PROGRAM** key two times.
3. Enter the number of doors the keypad will control (Up to 3. 2 or 3 accordingly).
4. Press the **PROGRAM** key. *The keypad is now programmed for multiple signals.*
5. At the powerhead press the **PRGRM SET** button for two seconds and the round LED turns blue. Then the long purple LED will flash.
6. Type the new PIN (3-8 digits).
7. Press the Up/Down key one time.
8. Assign a number to the door that the keypad will operate by pressing 1, 2 or 3.

(continued pg. 2)



Wireless Keypad

Synchronizing Multiple Doors (Continued)

9. Press that door number a second time.
10. Press that same door number a third time and the door will operate.
11. When the keypad turns dark, go back to step 5 to synchronize the additional doors.

To add another opener to a keypad that is already programmed to one opener, follow all the steps in the "Multiple Door Section". The original opener programmed to the keypad is door #1.

Door Operation from the Wireless Keypad:

Single door:

1. Enter the PIN number
2. Press the Up/Down Key

Multiple doors:

1. Enter the PIN number
2. Press the Up/Down Key
3. Enter the door number (1, 2 or 3)

NOTE: *The Keyless Entry Pad stays active for several seconds while lit and will stop or start the door with each touch of any button on the keypad.*

Changing an Existing PIN:

1. Enter the current PIN
2. Press the Program key one time
3. Key in the new PIN (3-8 digits)
4. Press the Program key one time

NOTE: *Unlike "Erasing a PIN to Factory Setting," there is no need to reprogram the opener after changing the PIN.*

Erasing a Keypad PIN to Factory Setting:

1. Press and hold both the keypad **PROGRAM** key and the **Up/Down** key for about five seconds.
2. The Keypad LED will slowly blink and then turn off. The keypad is successfully erased.
3. To create a new PIN, start with "Setting the PIN for the First Time".

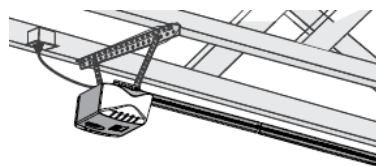

Clearing the Genie Operator from all Remotes and the Keyless Entry System.

1. Press the PRGRM SET button at the powerhead for two seconds. The *round* LED turns blue.
2. Upon releasing, the *long* LED flashes purple.
3. Press and hold the up (+) and down (-) buttons at the same time until both LED lights blink blue.

Need help or have any questions? Call our technical hotline at (800) 843-4084 option 3.

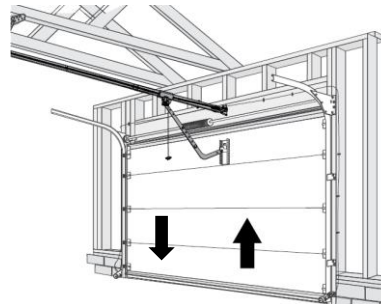
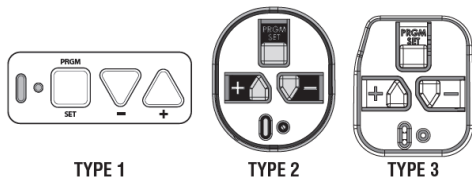

There are three types of programming button pads. All buttons perform the same function and programming for all types shown above.

Programming Genie Operators

The Following Steps

1. Down/Up Travel Limits
2. Setting the Force Control
3. Programming Additional Remotes

1. Travel Limits

Down Limit

- a. Connect the trolley to the rail.
- b. Press and hold the down arrow button (-) for two seconds or until the long blue LED turns on.
- c. Release the down arrow button (-) and the long LED color blue will begin to flash. The round LED will remain off.

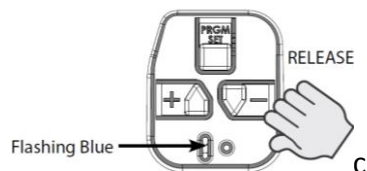
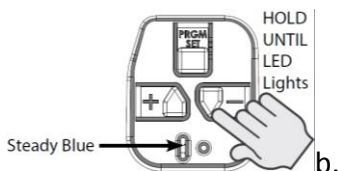

- d. Press and hold the down arrow button (-) until the garage door has fully closed.
- e. Use the up arrow (+) button to move the door up slightly if the door is too tight to the ground.
- f. Press and release the PRGM SET button once. Both LEDs turn color blue and then turn off.
- g. The closed travel limit is now programmed.



Up Limit

- a. Press and hold the up arrow button (+) for two seconds or until the long LED turns blue.
- b. Release the up arrow button (+) and the **round** blue LED will begin to flash. The long LED turns off.

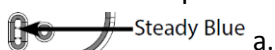

- c. Press and hold the up arrow button (+) and the door will begin moving, keep the button pressed in until the door is fully open. Press the down arrow button (-) if the door has opened too far.
- d. Press and release the PRGM SET button once. Both LEDs turn color blue and then turn off.
- e. The open travel limit is now programmed.

2. Force Control

- a. After programming the travel limits, set the opener's force control. Complete this by running the opener through a fully open and close cycle (uninterrupted) either using the wall control button or the programmed remote control.
- b. Press the open/close button **to close** the door.
- c. Press the open/close button **to open** the door.
- d. The automatic force control in the software is now configured.



3. Remote Controls

Note: The remote controls included with the operator come programmed from the factory for your convenience.

- a. To program any additional remotes, press and hold the PRGM SET button for two seconds until the round LED turns blue.
- b. Upon releasing, the long LED will begin to flash purple.
- c. Slowly press and release the remote control button two times. The LEDs on the garage door operator will turn purple, then turn blue and then turn off.
- d. Pressing the button a third time will move the garage door. The remote is programmed successfully.



Need help or have any questions? Call our technical hotline at (800) 843-4084 option 3.